



BMW 3 & 4 Series* (with NBT iDrive, without MOST® Amp) 2014-2016

* F30, F31, F32, F33, F34, F36, F80, F82, F83

Visit MetraOnline.com for more detailed information about the product and up-to-date vehicle specific applications

KIT FEATURES

- ISO DDIN radio provision
- Retains the factory climate controls
- Retains the factory ambient ashtray light (if equipped)
- Includes all necessary data interfaces, wiring harnesses, and antenna adapter, for a complete installation
- Painted black to match the factory dash

KIT COMPONENTS

- A) Radio trim panel • B) Radio brackets • C) Panel clips (2) • D) Radio screws (8) • E) ASWC-1 interface and wiring harness (not shown)
- F) Axxess interface and wiring harness (not shown) • G) Antenna adapter (not shown)

A

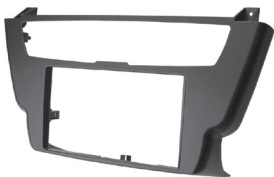

B

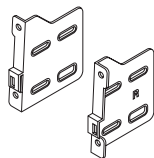

C



D



TABLE OF CONTENTS

Dash Disassembly	2
Kit Preparation	3
Kit Assembly	4
Axxess Interface Installation.....	5
Final Assembly.....	10

WIRING & ANTENNA CONNECTIONS

- Wiring Harness: Included with kit
- Antenna Adapter: Included with kit
- Steering Wheel Control Interface: Included with kit

TOOLS REQUIRED

- Cutting tool • Panel removal tool
- Phillips screwdriver • 3mm Allen screwdriver
- T-20 Torx screwdriver

Attention! Let the vehicle sit with the key out of the ignition for a few minutes before removing the factory radio. When testing the aftermarket equipment, ensure that all factory equipment is connected before cycling the key to ignition.

DASH DISASSEMBLY

1. Unclip, unplug, and remove the a/c vent panel above the radio. (Figure A)
2. Starting from the top, unclip and remove the panel below the climate controls. If an ashtray light is present, unclip and remove the light. (Figure B)
3. Remove (4) T-20 Torx screws securing the radio/climate-control panel, then unplug and remove the panel. (Figure C)

Note: The bottom screws will be re-purposed to install the radio assembly.

4. Remove either (2) or (4) T-20 Torx screws securing the radio chassis, depending on the radio equipped with the vehicle. Slide the radio chassis out, then unplug and remove. (Figure D)

Continue to Kit Preparation



(Figure A)

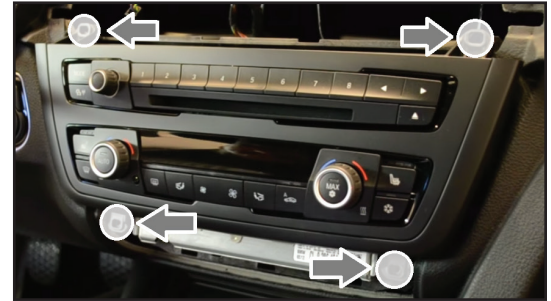

(Figure C)



(Figure B)

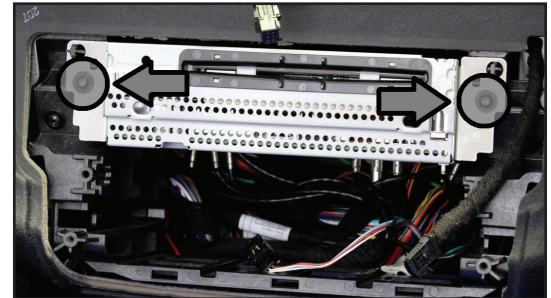

(Figure D)

KIT PREPARATION

Climate Control Assembly

1. Unplug the connector to the radio controls, then unclip and remove the climate controls from the radio/climate control panel. (Figure A)
2. Clip the climate controls into the radio trim panel. Ensure that the middle clip is lined up perfectly. (Figure B)
3. Attach the (2) panel clips provided onto the radio trim panel.

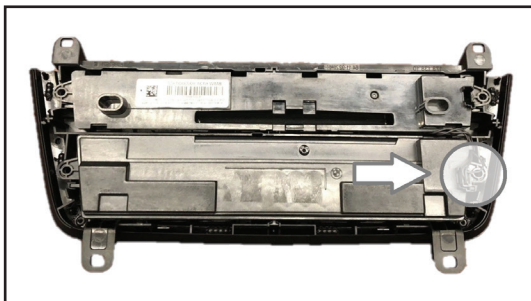

(Figure A)

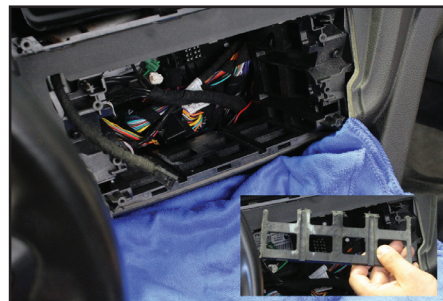

(Figure C)

Sub-dash Modification

4. Cut the sub-dash to allow room for the aftermarket radio. (Figure C)

Continue to Kit Assembly



(Figure B)

KIT ASSEMBLY

1. Secure the **radio brackets** to the radio using either the screws supplied with the radio, or the **radio screws** provided. (Figure A)

*Continue to Axxess
Interface Installation*

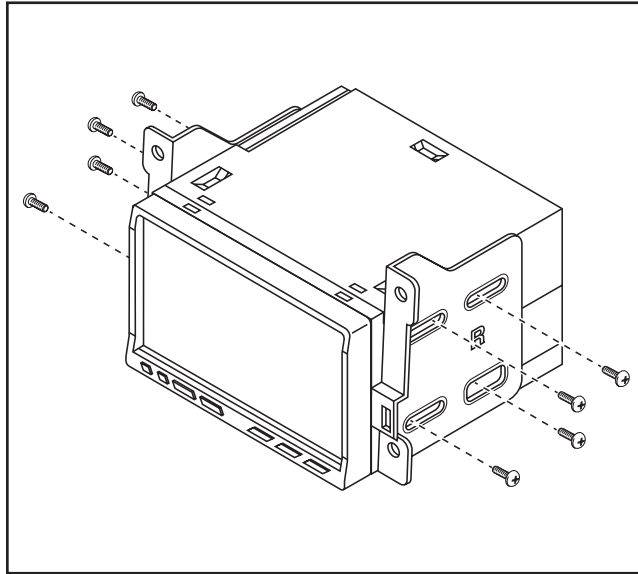

(Figure A)

AXXESS INTERFACE INSTALLATION

INTERFACE FEATURES

- Provides accessory power
- Retains audio/phone[†] controls on the steering wheel
- Provides NAV outputs (parking brake, reverse, speed sense)
- Retains warning chimes through an outboard speaker
- Comes with all necessary wiring to relocate the factory radio to retain vehicle settings
- Retains balance and fade
- Micro-B USB updatable

[†] Radio dependent

INTERFACE COMPONENTS

- 9317 interface
- 9317 harness
- ASWC-1 interface
- ASWC-1 harness
- Chime speaker
- Female 3.5mm connector with stripped leads
- HSD+2 extension cable
- 4-pin data extension cable

TABLE OF CONTENTS

Connections.....	6
Installation.....	7
Programming.....	8
Harness Layout.....	9

TOOLS REQUIRED

- Crimping tool and connectors, or solder gun, solder, and heat shrink
- Tape • Wire cutter • Zip ties

CONNECTIONS

From the 9317 harness to the aftermarket radio:

- Connect the **Black** wire to the ground wire.
- Connect the **Yellow** wire to the battery wire.
- Connect the (2) **Red** wires to the accessory wire.

Note: There will an accessory wire from the **ASWC-1 harness** to connect as well.

- Connect the **Blue** wire to the amplifier turn-on wire, and also to the **Blue** wire from the antenna adapter provided with the kit.
- If the aftermarket radio has an illumination wire, connect the **Orange** wire to it.
- Connect the **Brown** wire to the mute wire.
- Connect the **Gray** wire to the right front positive speaker output.
- Connect the **Gray/Black** wire to the right front negative speaker output.
- Connect the **White** wire to the left front positive speaker output.
- Connect the **White/Black** wire to the left front negative speaker output.
- Connect the **Green** wire to the left rear positive speaker output.
- Connect the **Green/Black** wire to the left rear negative speaker output.
- Connect the **Purple** wire to the right rear positive speaker output.
- Connect the **Purple/Black** wire to the right rear negative output.

The following (3) wires are for multimedia/navigation radios that require these wires.

- Connect the **Blue/Pink** wire to the speed sense wire.
- Connect the **Green/Purple** wire to the reverse wire.
- Connect the **Light Green** wire to the parking brake wire.
- Disregard the **Red & White** RCA jacks, they will not be used in this application.

From the ASWC-1 harness to the aftermarket radio:

This harness is to be used if the vehicle is equipped with steering wheel controls.

- Connect the **Red** wire to the accessory wire.
- **For the radios listed below:** Connect the **female 3.5mm connector with stripped leads**, to the male 3.5mm SWC jack from the **ASWC-1 harness**. Any remaining wires tape off and disregard:
 - **Eclipse:** Connect the steering wheel control wire, normally **Brown**, to the **Brown/White** wire from the connector. Then connect the remaining steering wheel control wire, normally **Brown/White**, to the **Brown** wire from the connector.
 - **Metra OE:** Connect the steering wheel control Key 1 wire (**Gray**) to the **Brown** wire.
 - **Kenwood or select JVC with a steering wheel control wire:** Connect the **Blue/Yellow** wire to the **Brown** wire.
Note: If the Kenwood radio auto detects as a **JVC**, manually set the radio type to **Kenwood**. Refer to the **Changing Radio Type** document available at axessinterfaces.com/product/ASWC-1.
 - **XITE:** Connect the steering wheel control SWC-2 wire from the radio to the **Brown** wire.
 - **Parrot Asteroid Smart or Tablet:** Connect the 3.5mm jack into the **AX-SWC-PARROT** (sold separately). Then connect the 4-pin connector from the **AX-SWC-PARROT** to the radio.
Note: The radio must have rev. 2.1.4 or higher software.
 - **Universal “2 or 3 wire” radio:** Connect the steering wheel control wire, referred to as Key-A or SWC-1, to the **Brown** wire from the connector. Then connect the remaining steering wheel control wire, referred to as Key-B or SWC-2, to the **Brown/White** wire from the connector. If the radio comes with a third wire for ground, disregard this wire.
Note: After the interface has been programmed to the vehicle, refer to the manual provided with the radio for assigning the SWC buttons. Contact the radio manufacturer for more information.
- **For all other radios:** Connect the 3.5mm jack from the **ASWC-1 harness** into the jack from the aftermarket radio designated for an external steering wheel control interface. Please refer to the aftermarket radios manual if in doubt as to where the 3.5mm jack should connect to.

INSTALLATION

The 9317 harness is a factory radio relocation harness which also provides power and speaker connections for the aftermarket radio. Connections will be made at the radio location first, then at the location where the factory radio will be relocated to, usually the trunk area. Ensure that the main 40-pin connectors are oriented in the correct way as they will only plug in if oriented properly. A harness layout has been provided at the end of this section.

With the key in the off position:

1. At the radio location, chassis ground the **Black** wire with a ring terminal.
2. Connect the **9317 harness** to the **9317 interface**.
Note: Do not connect the **9317 harness** to the wiring harness in the vehicle until after step 13 is complete.
3. Connect the **ASWC-1 harness** to the **ASWC-1 interface**, and then to the **9317 interface**.
4. Connect the **4-pin data extension cable** to the **9317 harness**.
5. Connect the **HSD+2 extension cable** to the HSD+2 cable disconnected from the factory radio chassis.
6. Locate the factory antenna connector in the dash and complete all necessary connections to the radio. Use the antenna adapter provided to adapt the factory antenna connector to the aftermarket radio.

Chime Speaker Installation

7. Zip tie the **chime speaker** under the dash to a location where it will be clearly heard by the driver. Route the **chime speaker** harness to the radio location.
8. Connect the **chime speaker** harness to the **9317 harness**.

Radio Chassis Relocation

9. Find a suitable place in the trunk of the vehicle to relocate the factory radio chassis*. Other choices are at the discretion of the Installer performing the installation. Route the **9317 harness**, **HSD+2 extension cable**, and **4-pin data extension cable** to this location.
* Figure A shows the factory radio chassis (non-NAV model).
10. Locate a suitable place close to the radio chassis to ground the **Black** wire with a ring terminal.
11. Connect the **4-pin data extension cable** to the **9317 harness**.
12. Connect the **9317 harness** and **HSD+2 extension cable** to the factory radio chassis.
13. Connect the **Yellow** wire with a fuse-holder directly to the battery, or to an empty “battery power” cavity in the fuse box.
14. At the radio location, connect the **9317 harness** to the wiring harness in the vehicle.
15. Disregard the 10-pin harness, it will not be used in this application.

Attention! If retaining steering wheel controls, ensure that the SWC jack/wire is connected to the radio before proceeding. If this step is skipped, the interface will need to be reset for the steering wheel controls to function.



(Figure A)

PROGRAMMING

1. Press and hold the **Volume Up** button on the steering wheel.
2. Turn the ignition on, the L.E.D. in the **ASWC-1 interface** will start flashing rapidly, which means the **ASWC-1 interface** is looking for the vehicle and the radio.
3. After a few seconds the L.E.D. should stop flashing rapidly, then go out for approximately 2 seconds.
4. After 2 seconds there will be a series of 7 **Green** flashes, some short, and some long. The long flashes represent the wires that are connected from the vehicle to the **ASWC-1 interface**. The 3rd, 4th, 5th, and 6th flashes should be longer.
5. The L.E.D. will pause for another 2 seconds, then flash **Red** up to 18 times depending on which radio is connected to the **ASWC-1 interface**. Refer to the **L.E.D. Feedback** section for more information.
6. This is the end of the auto detection stage. If the **ASWC-1 interface** detected the vehicle and radio successfully, the L.E.D. will light up solid. If not, refer to the troubleshooting documents available at axessinterfaces.com/product/ASWC-1.
7. Test all functions of the installation for proper operation before reassembling the dash. Refer to the **ASWC-1 Steering Wheel Control** documents available at axessinterfaces.com/product/ASWC-1 for customizing the buttons, if so desired.

Note: If the factory radio has been relocated to retain the vehicle settings, hold the **Mode** button on the steering wheel for 8-10 seconds until a chime is heard from the outboard chime speaker. The steering wheel control buttons will now control the factory radio instead. To revert back to aftermarket radio control, hold the **Mode** button again for 8-10 seconds.

L.E.D. Feedback

The (18) **Red** L.E.D. flashes represent the brand of radio the **ASWC-1 interface** believes it is connected to. Each flash count represents a different radio Manufacturer. For example, if you are installing a JVC radio, the **ASWC-1 interface** will flash **Red** (5) times, then stop. Following is a legend that explains which radio Manufacturer corresponds to the flash count provided.

L.E.D. feedback legend

Flash Count	Radio
1	Eclipse (type 1) †
2	Kenwood ‡
3	Clarion (type 1) †
4	Sony / Dual
5	JVC
6	Pioneer / Jensen
7	Alpine *
8	Visteon
9	Valor

Flash Count	Radio
10	Clarion (type 2) †
11	Metra OE
12	Eclipse (type 2) †
13	LG
14	Parrot **
15	XITE
16	Philips
17	TBA
18	JBL

* If the **ASWC-1 interface** flashes **Red** (7) times, and an **Alpine** radio is not installed, that means an open connection. Verify that the 3.5mm jack is connected to the correct steering wheel jack/wire in the radio.

** The **AX-SWC-PARROT** is required (sold separately). Also, the software in the radio must be rev. 2.1.4 or higher.

† If a **Clarion** radio is installed and the steering wheel controls do not function, change the radio type to the opposite **Clarion** radio type; likewise for **Eclipse**. Refer to the **Changing Radio Type** document available at axessinterfaces.com/product/ASWC-1.

‡ If a **Kenwood** radio is installed and the L.E.D. feedback comes back showing as a **JVC** radio, change the radio type to **Kenwood**. Refer to the **Changing Radio Type** document available at axessinterfaces.com/product/ASWC-1.

HARNESS LAYOUT

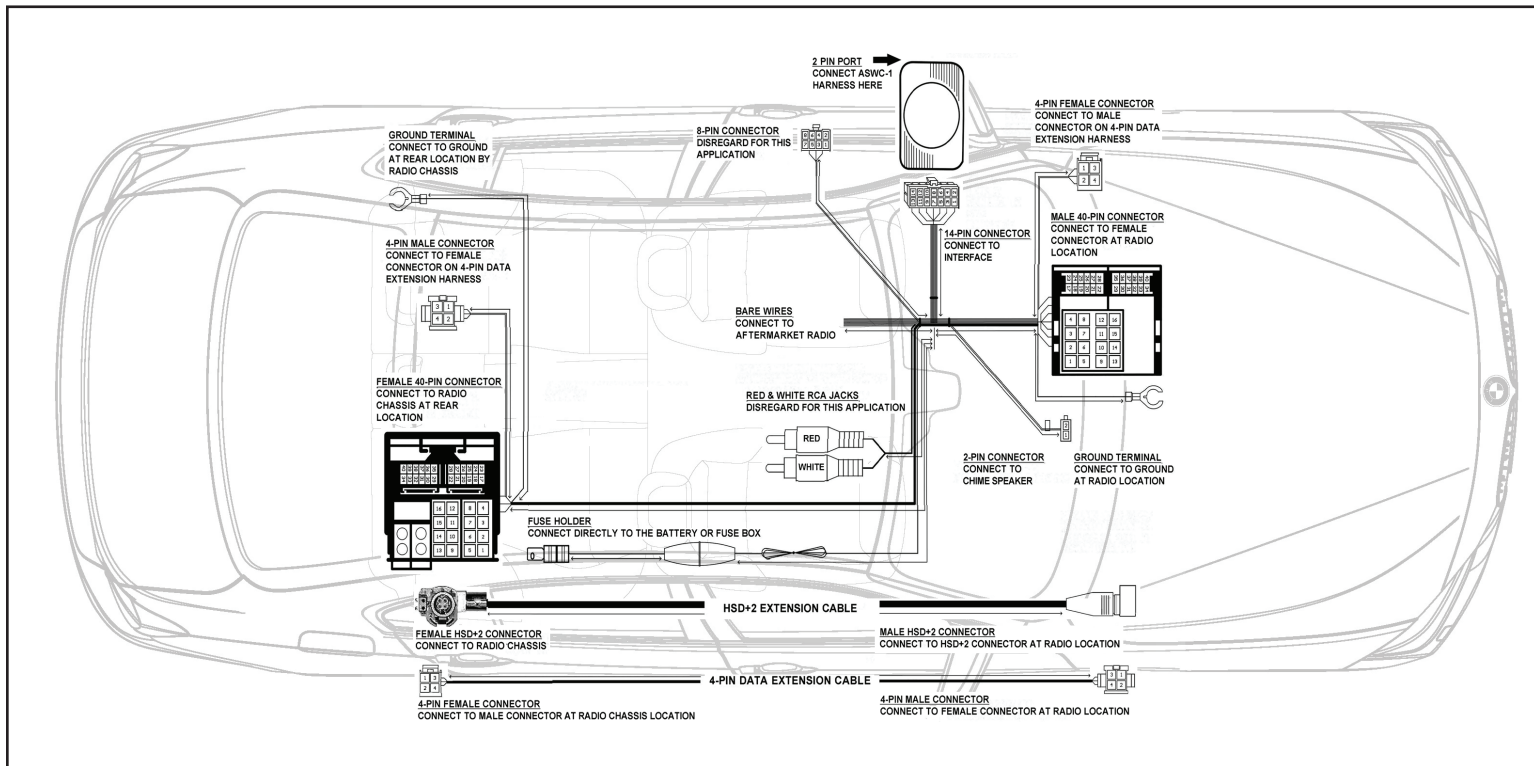

FINAL ASSEMBLY

1. Secure the radio assembly to the dash using the factory screws.
2. Clip the **radio trim panel** to the dash, then secure it using the factory screws. If the vehicle is equipped with an ashtray light, attach it to the panel. (Figure A)
3. Reconnect and clip in the a/c vent panel back to the vehicle to complete the installation.

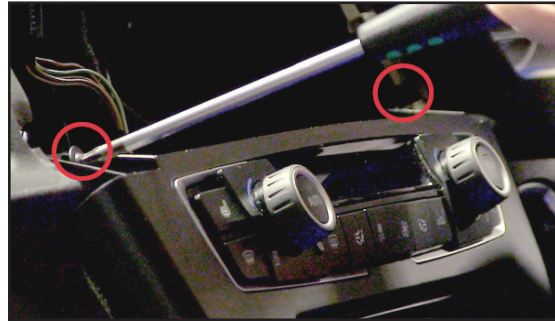

(Figure A)



95-9317B
INSTALLATION INSTRUCTIONS



If you are having difficulties with the installation of this product, contact our Tech Support line either by phone at **1-800-253-TECH**, or email at **techsupport@metra-autosound.com**. Before doing so, look over the instruction booklet a second time and ensure that the installation was performed exactly as the instruction booklet is stated. Have the vehicle apart and ready to perform troubleshooting steps before contacting Metra/Axxess Tech Support.



KNOWLEDGE IS POWER

Enhance your installation and fabrication skills by enrolling in the most recognized and respected mobile electronics school in our industry. Log onto www.installerinstitute.com or call 800-354-6782 for more information and take steps toward a better tomorrow.



Metra recommends MECP certified technicians